

551.50



EN 71

ASTM F963



- DK** Reservedele
- GB** Spare Parts
- DE** Ersatzteile

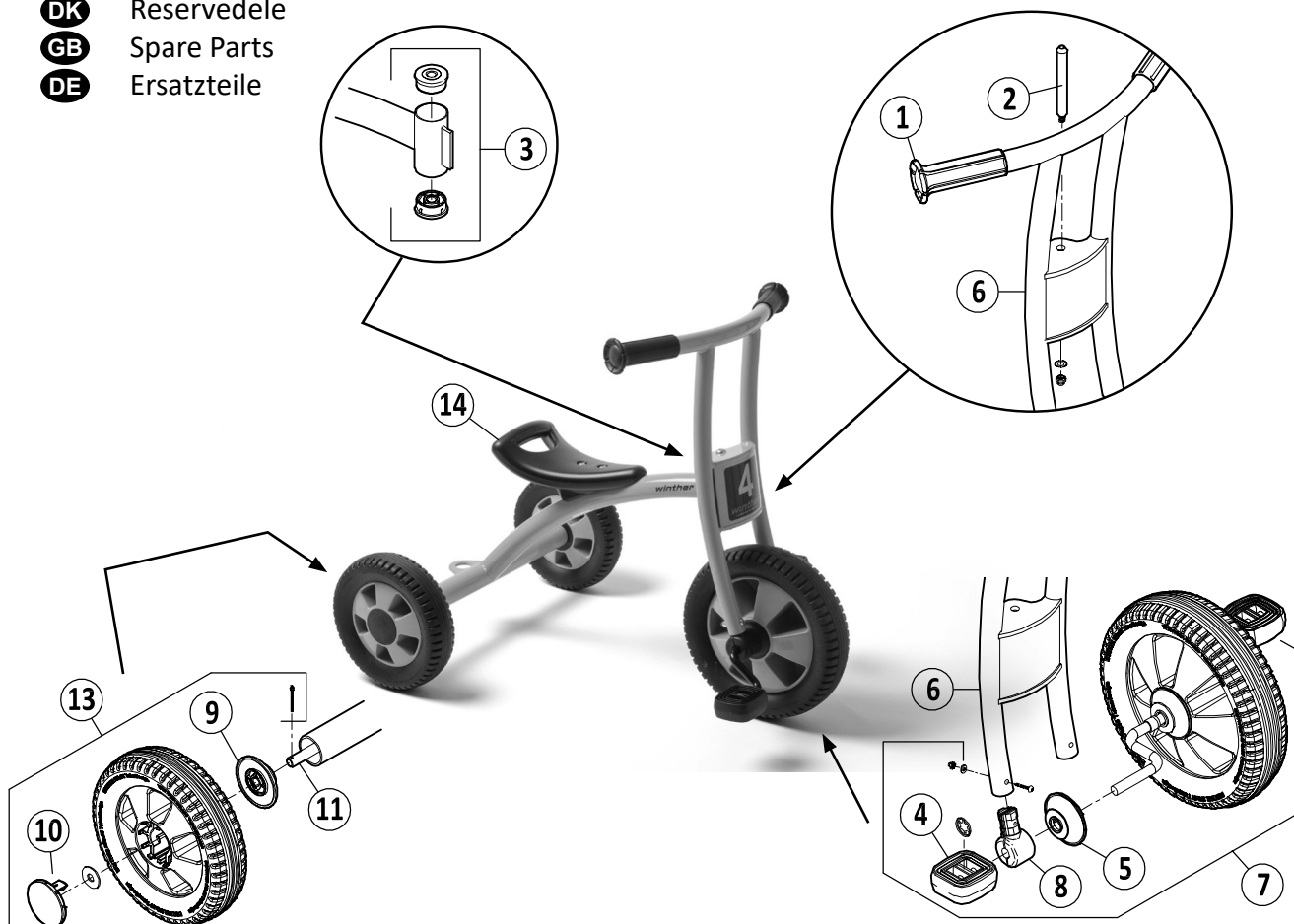

Pos.		Pos.	
1	x2	8	x2 x2 x1
2	x1 x2 x1 x1 x1	9	x2
3	x2	10	x2
4	x2 x2	11	x1 x2 x2
5	x2	12	
6		13	
7		14	

551.50



EN 71

ASTM
F963



- DK** Reservedele
- GB** Spare Parts
- DE** Ersatzteile

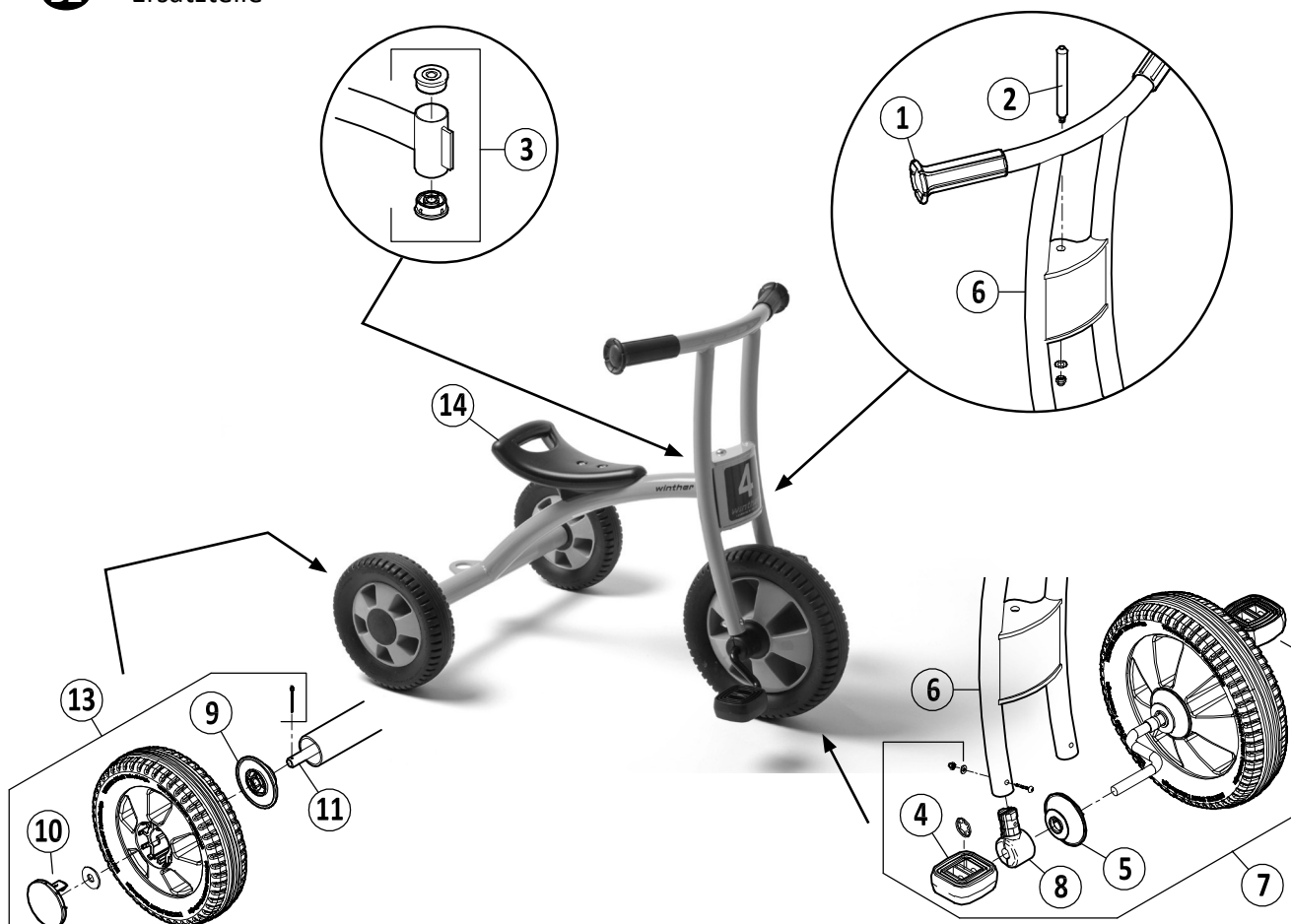

551.50					
Version					
Pos.	1.0				
1	50403				
2	50401				
3	50404				
4	50410				
5	50270				
6	50271				
7	50278				
8	50406				
9	50283				
10	50284				
11	50292				
12	-				
13	50287				
14	50480				
15	-				

